

Model No. DUR193 CORDLESS GRASS TRIMMER

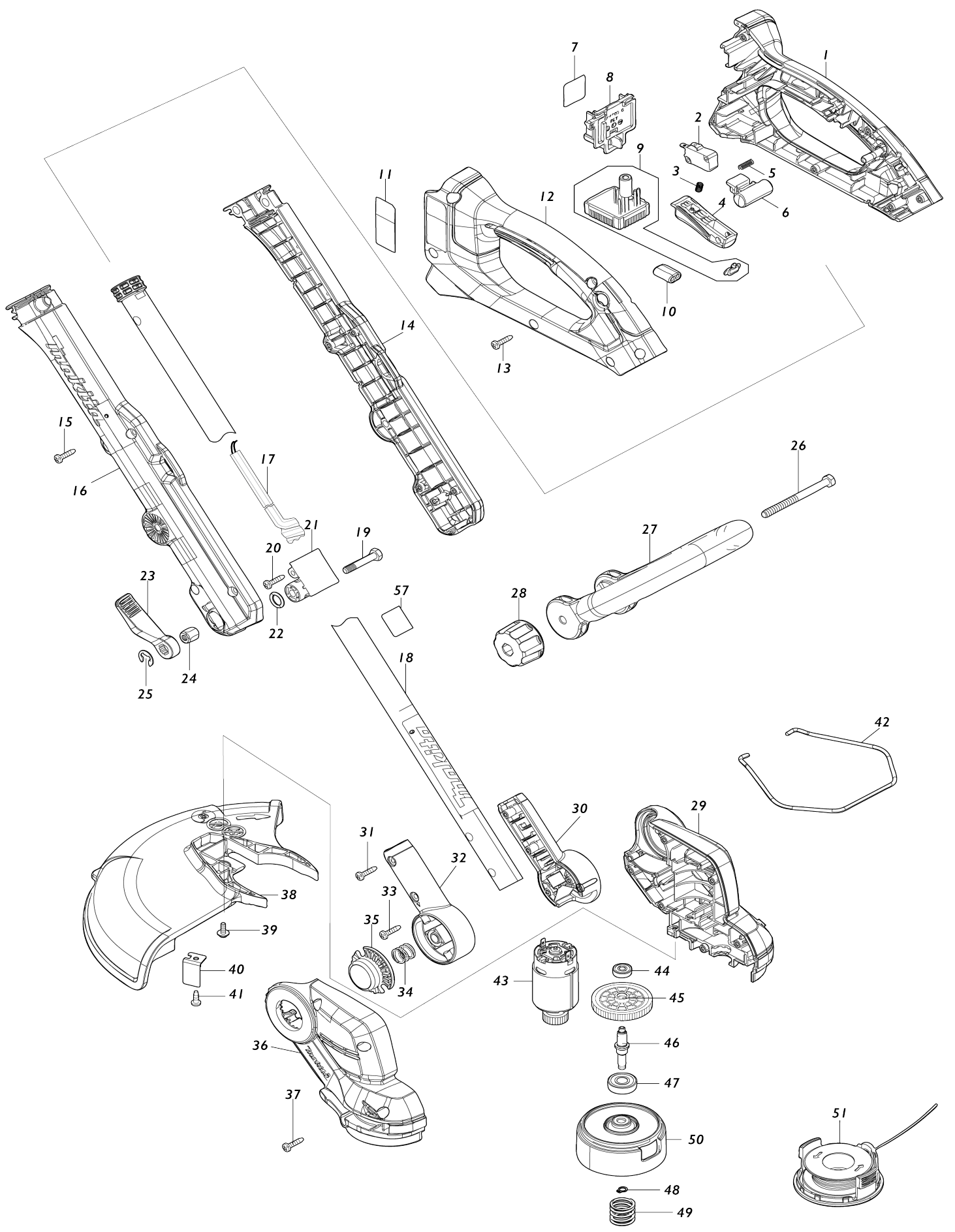

Model No.DUR193 CORDLESS GRASS TRIMMER

Artike l-Nr.	Teile-Nr.	Beschreibung	Austa uschb arkeit	Anzah l	Neu/A lt	Notiz 1	Notiz 2
001	183V19-7	Griffgehäuse-Set		1			
C10	263005-3	Gummistift 6		2			
D10		INC. 12					
002	650744-8	Schalter D3V-16-3C26		1			
003	231473-8	Druckfeder 4		1			
004	413G06-5	Schalthebel		1			
005	231473-8	Druckfeder 4		1			
006	413G05-7	Verriegelungsknopf		1			
007	8116T1-7	Serien-Nr.-Schild DUR193		1			
008	644809-6	Klemme		1			
009	620J15-7	Controller		1			
010	688172-7	Leitungsfilter		1	*		
010-1	688172-7	Leitungsfilter	O	1			
011	8116S5-2	Typenschild DUR193		1			
012	183V19-7	Griffgehäuse-Set		1			
C10	263005-3	Gummistift 6		2			
D10		INC. 1					
013	266326-2	Bindekopf-Blechschrabe 4X18		6	*		
013-1	265B67-9	Bindekopf-Blechschrabe 4X18	O	6			
014	183V18-9	Rohrhalter-Set		1			
D10		INC. 16					
015	266326-2	Bindekopf-Blechschrabe 4X18		4	*		
015-1	265B67-9	Bindekopf-Blechschrabe 4X18	O	4			
016	183V18-9	Rohrhalter-Set		1			
D10		INC. 14					
017	660500-8	Stromversorgungskabel		1			
018	141J63-8	Rohr 22 komplett D		1			
C10	413G07-3	Rohrkappe		1			
C20	8049C7-1	Firmenschild MAKITA Logo		1			
C30	8045G0-9	Hinweisschild		1			
019	265C82-9	Sechskantschraube M6X35		1			
020	266326-2	Bindekopf-Blechschrabe 4X18		1	*		
020-1	265B67-9	Bindekopf-Blechschrabe 4X18	O	1			
021	413G10-4	Hülse		1			
022	213105-9	O-Ring 11		1			
023	413G09-9	Hebel 60		1			
024	252133-9	Sechskantmutter M6		1			
025	961014-3	Anschlagring (EXT) E-8		1			
026	265C83-7	Sechskantschraube M6X75		1			
027	413F75-0	Bügelgriff		1			
028	264072-1	Rändelmutter M6		1	*		
028-1	264072-1	Rändelmutter M6	O	1			
029	183V20-2	Motorgehäuse-Set		1			
C10	263005-3	Gummistift 6		2			
C20	346275-0	Platte		1			
D10		INC. 36					
030	183V17-1	Rohrhalter-Set		1			
D10		INC. 32					

031	266326-2	Bindekopf-Blechschaube 4X18		2	*		
031-1	265B67-9	Bindekopf-Blechschaube 4X18	O	2			
032	183V17-1	Rohrhalter-Set		1			
D10		INC. 30					
033	266326-2	Bindekopf-Blechschaube 4X18		2	*		
033-1	265B67-9	Bindekopf-Blechschaube 4X18	O	2			
034	231113-8	Druckfeder 12		1			
035	413G08-1	Verriegelungsknopf B		1			
036	183V20-2	Motorgehäuse-Set		1			
C10	263005-3	Gummistift 6		2			
C20	346275-0	Platte		1			
D10		INC. 29					
037	266326-2	Bindekopf-Blechschaube 4X18		6	*		
037-1	265B67-9	Bindekopf-Blechschaube 4X18	O	6			
038	413F73-4	Schutzhaube		1			
039	911119-9	Flachkopfschraube M4X12 WG		1			
040	347977-1	Schneider		1			
041	266427-6	Bindekopf-Blechschaube 4X12		1	*		
041-1	265C54-4	TAPPING SCREW 4X12	O	1			
042	327969-6	Drahtbügel		1			
043	629B13-0	Gleichstrommotor		1	*		
043-1	629B89-7	Gleichstrommotor	<	1			
044	210235-7	Rillenkugellager 625ZZ		1			
045	227949-1	Schrägstirnrad 48		1			
046	327967-0	Messerwelle		1			
047	210217-9	Rillenkugellager 609ZZ		1			
048	961002-0	Haltering (EXT) S-6		1			
049	231352-0	Druckfeder 17		1			
050	413F76-8	Spulenhalter		1			
051	191Y39-5	Fadenspule MG		1			
057	800A43-6	Hinweisschild geräusch 86DB		1			
A01	127508-0	Band Baugruppe		1			
A04	***DC18RC	Ladegerät DC18RC		1			
D10		COMPO-PARTS					
A05	197600-6	Akkusatz BL1830B		1			
A06	450128-8	Kontaktschutzkappe		1			
A04	***DC18WC	DC18WC BATTERY CHARGER		1			

Bitte geben Sie bei Ihrer Bestellung die Teile-Nr. an.

Druckdatum 06/11/2024

ENGLISH

Annex A: EU Declaration of Conformity

We as the manufacturers: **Makita Europe N.V.**, Business address: **Jan-Baptist Vinkstraat 2, 3070 Kortenberg, BELGIUM**. Authorize **Kazuhisa Makino** for the compilation of the technical file and declare under our sole responsibility that the product(s); Designation: **Cordless Grass Trimmer**. Designation of Type(s): **DUR193**. Fulfills all the relevant provisions of **2006/42/EC** and also fulfills all the relevant provisions of the following EC/EU Directives: **2014/30/EU, 2011/65/EU, 2000/14/EC**. and are manufactured in accordance with the following Harmonised Standards: **EN 60335-1:2012+A11:2014+A13:2017+A1:2019+A14:2019+A2:2019, EN 50636-2-91:2014, EN IEC 55014-1:2021, EN IEC 55014-2:2021, EN IEC 63000:2018**.

The conformity assessment procedure required by Directive **2000/14/EC** was in accordance with **Annex VI**.

- Measured Sound Power Level: **83.8 dB(A)**,

- Guaranteed Sound Power Level: **86 dB(A)**.

Notified Body: **VDE Prüf- und Zertifizierungsinstitut GmbH, Merianstraße 28, 63069 Offenbach, Germany**. Identification number: **0366**

Place of declaration: **Kortenberg, Belgium**. Responsible person: **Kazuhisa Makino, Director - Makita Europe N.V.** (date and signature on the last page)

FRANÇAIS

Annexe A : Déclaration de conformité UE

Nous, **Makita Europe N.V.**, en tant que fabricant, ayant pour adresse commerciale : **Jan-Baptist Vinkstraat 2, 3070 Kortenberg, Belgique**, autorisons **Kazuhisa Makino** à compiler le fichier technique et déclarons sous notre entière responsabilité que le produit ; désignation : **Coupe Herbe Sans Fil**, désignation du (des) type(s) : **DUR193**. Respecte(nt) toutes les dispositions pertinentes de la directive **2006/42/EC** ainsi que celles des directives CE/UE suivantes : **2014/30/EU, 2011/65/EU, 2000/14/EC**, et est (sont) fabriqué(s) conformément aux normes harmonisées suivantes : **EN 60335-1:2012+A11:2014+A13:2017+A1:2019+A14:2019+A2:2019, EN 50636-2-91:2014, EN IEC 55014-1:2021, EN IEC 55014-2:2021, EN IEC 63000:2018**.

La procédure d'évaluation de la conformité requise par la Directive **2000/14/EC** a été réalisée en conformité avec l'**Annexe VI**.

- Niveau de puissance acoustique mesuré : **83,8 dB(A)**,

- Niveau de puissance acoustique garanti : **86 dB(A)**.

Organisme notifié : **VDE Prüf- und Zertifizierungsinstitut GmbH, Merianstraße 28, 63069 Offenbach, Allemagne**. Numéro d'identification : **0366**

Lieu de la déclaration : **Kortenberg, Belgique**. Responsable : **Kazuhisa Makino, Directeur – Makita Europe N.V.** (date et signature sur la dernière page)

DEUTSCH

Anhang A: EU-Konformitätserklärung

Wir als die Hersteller: **Makita Europe N.V.**, Geschäftsadresse: **Jan-Baptist Vinkstraat 2, 3070 Kortenberg, Belgien**. beauftragen **Kazuhisa Makino** mit der Zusammenstellung der technischen Dokumentation und erklären unter unserer alleinigen Verantwortung, dass das (die) Produkt(e); Bezeichnung: **Akku-Rasentrimmer**. Bezeichnung des (der) Typs (Typen): **DUR193**. Erfüllt alle relevanten Vorschriften von **2006/42/EC** sowie alle relevanten Vorschriften der folgenden EG/EU-Richtlinien: **2014/30/EU, 2011/65/EU, 2000/14/EC** und werden gemäß den folgenden harmonisierten Normen gefertigt: **EN 60335-1:2012+A11:2014+A13:2017+A1:2019+A14:2019+A2:2019, EN 50636-2-91:2014, EN IEC 55014-1:2021, EN IEC 55014-2:2021, EN IEC 63000:2018**.

Das von der Richtlinie **2000/14/EC** geforderte Konformitätsbewertungsverfahren war in Übereinstimmung mit **Anhang VI**.

- Gemessener Schalleistungspegel: **83,8 dB(A)**,

- Garantierter Schalleistungspegel: **86 dB(A)**.

Benannte Stelle: **VDE Prüf- und Zertifizierungsinstitut GmbH, Merianstraße 28, 63069 Offenbach, Deutschland**. Identifizierungsnummer: **0366**

Ort der Erklärung: **Kortenberg, Belgien**. Verantwortliche Person: **Kazuhisa Makino, Direktor – Makita Europe N.V.** (Datum und Unterschrift auf der letzten Seite)

ITALIANO

Allegato A: Dichiarazione di conformità UE

In qualità di fabbricante, **Makita Europe N.V.**, con indirizzo aziendale **Jan-Baptist Vinkstraat 2, 3070 Kortenberg, Belgio**, autorizza **Kazuhisa Makino** alla compilazione della documentazione tecnica e dichiara, sotto la propria ed esclusiva responsabilità, che il prodotto o i prodotti con designazione **Tagliabordi a batteria**, e con designazione del tipo o dei tipi: **DUR193**, è conforme a tutte le disposizioni rilevanti della normativa **2006/42/EC**, e che è, inoltre, conforme a tutte le disposizioni rilevanti delle Direttive CE/UE seguenti, **2014/30/EU, 2011/65/EU, 2000/14/EC**, ed è fabbricato in conformità agli Standard Armonizzati seguenti, **EN 60335-1:2012+A11:2014+A13:2017+A1:2019+A14:2019+A2:2019, EN 50636-2-91:2014, EN IEC 55014-1:2021, EN IEC 55014-2:2021, EN IEC 63000:2018**.

La procedura di determinazione della conformità richiesta dalla Direttiva **2000/14/EC** è stata eseguita conformemente all'**Allegato VI**.

- Livello di potenza sonora misurato: **83,8 dB(A)**,

- Livello di potenza sonora garantito: **86 dB(A)**.

Ente notificato: **VDE Prüf- und Zertifizierungsinstitut GmbH, Merianstraße 28, 63069 Offenbach, Germania**. Numero di identificazione: **0366**

Sede della dichiarazione: **Kortenberg, Belgio**. Persona responsabile: **Kazuhisa Makino, Direttore – Makita Europe N.V.** (data e firma sull'ultima pagina)

NEDERLANDS

Aanhangsel A: EU-verklaring van conformiteit

Wij als de fabrikant: **Makita Europe N.V.**, vestigingsadres: **Jan-Baptist Vinkstraat 2, 3070 Kortenberg, België**, volmachtigen **Kazuhisa Makino** tot samenstelling van het technisch dossier en verklaren als enige verantwoordelijke dat het product(en), omschrijving: **Accugrastrimmer**; type nummer(s): **DUR193**; voldoet aan alle relevante voorschriften van richtlijn **2006/42/EC** en voldoet tevens aan de relevante voorschriften van de volgende EG/EU-richtlijnen: **2014/30/EU, 2011/65/EU, 2000/14/EC** en is vervaardigd in overeenstemming met de volgende geharmoniseerde normen: **EN 60335-1:2012+A11:2014+A13:2017+A1:2019+A14:2019+A2:2019, EN 50636-2-91:2014, EN IEC 55014-1:2021, EN IEC 55014-2:2021, EN IEC 63000:2018**.

De conformiteitsbeoordelingsprocedure vereist door Richtlijn **2000/14/EC** van in overeenstemming met **Aanhangsel VI**.

- Gemeten geluidsvermogeniveau: **83,8 dB(A)**,
- Gegarandeerd geluidsvermogeniveau: **86 dB(A)**.
Organisme notificeerd: **VDE Prüf- und Zertifizierungsinstitut GmbH, Merianstraße 28, 63069 Offenbach, Duitsland**.
Identificatienummer: **0366**

Plaats van verklaring: **Kortenberg, België**. Verantwoordelijke persoon: **Kazuhisa Makino, Directeur – Makita Europe N.V.** (datum en handtekening op de laatste pagina)

ESPAÑOL

Anexo A: Declaración UE de conformidad

Nosotros como los fabricantes: **Makita Europe N.V.**, Dirección comercial: **Jan-Baptist Vinkstraat 2, 3070 Kortenberg, Bélgica**. Autorizamos a **Kazuhisa Makino** para la compilación del archivo técnico y declaramos ante nuestra sola responsabilidad que el(los) producto(s); Designación: **Cortador Inalámbrico de Pasto**. Designación de tipo(s): **DUR193**. Cumple todas las provisiones pertinentes de **2006/42/EC** y también cumple con todas las provisiones pertinentes de las Directivas CE/UE siguientes: **2014/30/EU, 2011/65/EU, 2000/14/EC** y está fabricado de acuerdo con los estándares unificados siguientes: **EN 60335-1:2012+A11:2014+A13:2017+A1:2019+A14:2019+A2:2019, EN 50636-2-91:2014, EN IEC 55014-1:2021, EN IEC 55014-2:2021, EN IEC 63000:2018**.

El procedimiento de valoración de conformidad requerido por la Directiva **2000/14/EC** ha sido realizado de acuerdo con el **Anexo VI**.

- Nivel de potencia de sonido medido: **83,8 dB(A)**,
- Nivel de potencia de sonido garantizado: **86 dB(A)**.
Organismo facultativo: **VDE Prüf- und Zertifizierungsinstitut GmbH, Merianstraße 28, 63069 Offenbach, Alemania**.
Número de identificación: **0366**

Lugar de la declaración: **Kortenberg, Bélgica**. Persona responsable: **Kazuhisa Makino, Director – Makita Europe N.V.** (fecha y firma en la última página)

PORTUGUÊS

Anexo A: Declaração de conformidade da UE

A empresa, na qualidade de fabricante: **Makita Europe N.V.**, Endereço comercial: **Jan-Baptist Vinkstraat 2, 3070 Kortenberg, Bélgica**. Autorizamos **Kazuhisa Makino** a realizar a compilação do ficheiro técnico e declaramos, ao abrigo da nossa própria responsabilidade, que o(s) produto(s); Designação: **TESOURA PARA GRAMA A BATERIA**. Designação de tipo(s): **DUR193**. Cumpre todas as indicações relevantes da **2006/42/EC**, cumprindo ainda todas as indicações relevantes das seguintes Diretivas CE/UE: **2014/30/EU, 2011/65/EU, 2000/14/EC** e são fabricados de acordo com as seguintes Normas Harmonizadas: **EN 60335-1:2012+A11:2014+A13:2017+A1:2019+A14:2019+A2:2019, EN 50636-2-91:2014, EN IEC 55014-1:2021, EN IEC 55014-2:2021, EN IEC 63000:2018**.

O procedimento de avaliação da conformidade exigido pela Diretiva **2000/14/EC** estava conforme o **anexo VI**.

- Nível de potência sonora medido: **83,8 dB(A)**,
- Nível de potência sonora garantido: **86 dB(A)**.
Organismo notificado: **VDE Prüf- und Zertifizierungsinstitut GmbH, Merianstraße 28, 63069 Offenbach, Alemanha**.
Número de identificação: **0366**

Local da declaração: **Kortenberg, Bélgica**. Pessoa responsável: **Kazuhisa Makino, Diretor – Makita Europe N.V.** (data e assinatura na última página)

DANSK

Tillæg A: EU-konformitetserklæring

Vi som producent: **Makita Europe N.V.**, Forretningsadresse: **Jan-Baptist Vinkstraat 2, 3070 Kortenberg, Belgien**, autoriserer **Kazuhisa Makino** til kompilationen af den tekniske fil og erklærer, under vores eneansvar, at produktet (produkterne), Betegnelse: **Akku græstrimmer**. Betegnelse for type (typer): **DUR193**, opfylder alle de relevante betingelser for **2006/42/EC** og opfylder desuden alle de relevante betingelser i følgende EF/EU-direktiver: **2014/30/EU, 2011/65/EU, 2000/14/EC** og er fremstillet i overensstemmelse med de følgende harmoniserede standarder: **EN 60335-1:2012+A11:2014+A13:2017+A1:2019+A14:2019+A2:2019, EN 50636-2-91:2014, EN IEC 55014-1:2021, EN IEC 55014-2:2021, EN IEC 63000:2018**.

Fremgangsmåden for den konformitetsfastsættelse, som kræves i Direktiv **2000/14/EC**, er i overensstemmelse med **tillæg VI**.

- Målt lydeffektiveau: **83,8 dB(A)**,
- Garanteret lydeffektiveau: **86 dB(A)**.
Notificeret organisation: **VDE Prüf- und Zertifizierungsinstitut GmbH, Merianstraße 28, 63069 Offenbach, Tyskland**. Identifikationsnummer: **0366**
Sted for erklæring: **Kortenberg, Belgien**. Ansvarlig person: **Kazuhisa Makino, Direktør – Makita Europe N.V.** (dato og underskrift på den sidste side)

ΕΛΛΗΝΙΚΑ

Παράρτημα Α: Δήλωση Συμμόρφωσης ΕΕ

Εμείς ως οι κατασκευαστές: **Makita Europe N.V.**, Διεύθυνση επιχείρησης: **Jan-Baptist Vinkstraat 2, 3070 Kortenberg, Βέλγιο**. Εξουσιοδοτούμε τον **Kazuhisa Makino** για τη σύνταξη του τεχνικού αρχείου και δηλώνουμε, υπό την αποκλειστική ευθύνη μας, ότι το(α) προϊόν(τα), Χαρακτηρισμός: **Φορητό κουρευτικό γκαζόν**. Χαρακτηρισμός τύπου(ων): **DUR193**. Ικανοποιεί όλες τις σχετικές διατάξεις της Οδηγίας **2006/42/EC** και επίσης ικανοποιεί όλες τις σχετικές διατάξεις των ακόλουθων Οδηγιών ΕΚ/ΕΕ: **2014/30/EU, 2011/65/EU, 2000/14/EC** και κατασκευάζεται σύμφωνα με τα ακόλουθα εναρμονισμένα πρότυπα: **EN 60335-1:2012+A11:2014+A13:2017+A1:2019+A14:2019+A2:2019, EN 50636-2-91:2014, EN IEC 55014-1:2021, EN IEC 55014-2:2021, EN IEC 63000:2018**.

Η διαδικασία αξιολόγησης της συμμόρφωσης που απαιτείται σύμφωνα με την Οδηγία **2000/14/EC** ήταν σε συμφωνία με το **Παράρτημα VI**.

- Μετρούμενη στάθμη ηχητικής ισχύος: **83,8 dB(A)**,

- Εγγυημένη στάθμη ηχητικής ισχύος: **86 dB(A)**.

Κοινοποιημένος φορέας: **VDE Prüf- und Zertifizierungsinstitut GmbH, Merianstraße 28, 63069 Offenbach, Γερμανία**. Αναγνωριστικός αριθμός: **0366**

Τόπος της δήλωσης: **Kortenberg, Βέλγιο**. Υπεύθυνος: **Kazuhisa Makino, Διευθυντής – Makita Europe N.V.** (ημερομηνία και υπογραφή στην τελευταία σελίδα)

TÜRKÇE

Ek A: AB Uygunluk Bildirimi

Üretici olarak biz, iş adresi **Jan-Baptist Vinkstraat 2, 3070 Kortenberg, Belçika** olan **Makita Europe N.V.**; **Kazuhisa Makino**'yu teknik dosyanın hazırlanması için yetkilendiriyor ve tek sorumlu olarak Ürün Adı: **Aküülü Yan Tırpan Model adı: DUR193** olan ürünün/ürünlerin **2006/42/EC**'nin ilgili tüm hükümlerinin gerekliliklerini yerine getirdiğini, ayrıca **2014/30/EU, 2011/65/EU, 2000/14/EC** AT/AB Direktiflerinin ilgili tüm hükümlerinin gerekliliklerini yerine getirdiğini ve **EN 60335-1:2012+A11:2014+A13:2017+A1:2019+A14:2019+A2:2019, EN 50636-2-91:2014, EN IEC 55014-1:2021, EN IEC 55014-2:2021, EN IEC 63000:2018** Eşdeğer Standartlarına uygun olarak üretildiğini beyan ediyoruz.

2000/14/EC Direktifinin gerektirdiği uygunluk değerlendirme prosedürü, **Ek VI**'e uygundur.

- Ölçülen ses gücü seviyesi: **83,8 dB(A)**,

- Beklenen ses gücü seviyesi: **86 dB(A)**.

Onaylanmış Kuruluş: **VDE Prüf- und Zertifizierungsinstitut GmbH, Merianstraße 28, 63069 Offenbach, Almanya**. Tanımlama numarası: **0366**

Beyan yeri: **Kortenberg, Belçika**. Sorumlu kişi: **Kazuhisa Makino, Müdür – Makita Europe N.V.** (tarih ve imza son sayfada bulunmaktadır)

SVENSKA

Bilaga A: EU-försäkran om överensstämmelse

I egenskap av tillverkare: **Makita Europe N.V.**, med företagsadress **Jan-Baptist Vinkstraat 2, 3070 Kortenberg, Belgien**, auktoriserar vi **Kazuhisa Makino** för sammanställningen av den tekniska dokumentationen och försäkrar under ansvar att produkten (eller produkterna) – Beteckning: **Batteridrivnen grästrimmer**. Typbeteckning: **DUR193**. – uppfyller alla relevanta bestämmelser i **2006/42/EC** och även uppfyller alla relevanta bestämmelser i följande EG/EU-direktiv: **2014/30/EU, 2011/65/EU, 2000/14/EC**, samt är tillverkade i enlighet med följande harmoniserade standarder: **EN 60335-1:2012+A11:2014+A13:2017+A1:2019+A14:2019+A2:2019, EN 50636-2-91:2014, EN IEC 55014-1:2021, EN IEC 55014-2:2021, EN IEC 63000:2018**.

Förfarandet vid bedömning av överensstämmelse som krävs enligt direktiv **2000/14/EC** i gjordes i enlighet med **bilaga VI**.

- Uppmätt ljudeffektnivå: **83,8 dB(A)**,

- Garanterad ljudeffektnivå: **86 dB(A)**.

Anmält organ: **VDE Prüf- und Zertifizierungsinstitut GmbH, Merianstraße 28, 63069 Offenbach, Tyskland**. Identifieringsnummer: **0366**

Plats för givande av försäkran: **Kortenberg, Belgien**. Ansvarig person: **Kazuhisa Makino, Direktör – Makita Europe N.V.** (datum och underskrift på sista sidan)

NORSK

Tillegg A: EU-samsvarserklæring

Vi, som produsenter:

Makita Europe N.V., Forretningsadresse: **Jan-Baptist Vinkstraat 2, 3070 Kortenberg, Belgia**

autoriserer **Kazuhisa Makino** til å kompilere den tekniske filen og erklærer under vårt eneansvar at produktet;

Betegnelsen: **Batteridrevet græsstrimmer**

Modellbetegnelse: **DUR193**. Oppfyller alle relevante bestemmelser i **2006/42/EC** og oppfyller også alle bestemmelser i følgende EF/EU-direktiv: **2014/30/EU, 2011/65/EU, 2000/14/EC** og er fremstilt i samsvar med følgende harmoniserte standarder: **EN 60335-1:2012+A11:2014+A13:2017+A1:2019+A14:2019+A2:2019, EN 50636-2-91:2014, EN IEC 55014-1:2021, EN IEC 55014-2:2021, EN IEC 63000:2018**.

Prosedyren for samsvarsvurdering, som kreves av direktiv **2000/14/EC**, var i overensstemmelse med **Tillegg VI**.

- Målt lydteffektnivå: **83,8 dB(A)**,

- Garanteret lydteffektnivå: **86 dB(A)**.

Varslet organ: **VDE Prüf- und Zertifizierungsinstitut GmbH, Merianstraße 28, 63069 Offenbach, Tyskland**. Identifikasjonsnummer: **0366**

Sted for erklæring: **Kortenberg, Belgia**.

Ansvarlig: **Kazuhisa Makino, Direktør – Makita Europe N.V.** (dato og signatur på siste side)

SUOMI

Liite A: EU-vaatimustenmukaisuusvakuutus

Vastuullinen valmistaja: **Makita Europe N.V.**, yrityksen osoite: **Jan-Baptist Vinkstraat 2, 3070 Kortenberg, Belgia**, valtuuttaa **Kazuhisa Makino** kokoamaan tekniset asiakirjat ja vakuuttaa omalla vastuullaan, että tuote (tuotteet); Laitteen nimi: **Akkukäyttöinen viimeistelyleikkuri**. Laitteen tyyppi (tyypit): **DUR193**. Täyttää kaikki direktiivin **2006/42/EC** olennaiset vaatimukset sekä täyttää myös kaikki seuraavien EY/EU-direktiivien olennaiset vaatimukset: **2014/30/EU, 2011/65/EU, 2000/14/EC** ja on valmistettu seuraavien yhdenmukaistettujen standardien: **EN 60335-1:2012+A11:2014+A13:2017+A1:2019+A14:2019+A2:2019, EN 50636-2-91:2014, EN IEC 55014-1:2021, EN IEC 55014-2:2021, EN IEC 63000:2018**.

Direktiivin **2000/14/EC** vaatima vaatimustenmukaisuusmenettely oli liitteen VI mukainen.

- Mitattu äänitehotaso: **83,8 dB(A)**,

- Taattu äänitehotaso: **86 dB(A)**.

Ilmoitettu laitos: **VDE Prüf- und Zertifizierungsinstitut GmbH, Merianstraße 28, 63069 Offenbach, Saksa**.
Tunnistenumero: **0366**

Ilmoituksen antopaikka: **Kortenberg, Belgia**. Vastuuhenkilö: **Kazuhisa Makino, johtaja – Makita Europe N.V.** (päivämäärä ja allekirjoitus viimeisellä sivulla)

LATVIEŠU

A pielikums: ES atbilstības deklarācija

Ražotājs **Makita Europe N.V.**, juridiskā adrese: **Jan-Baptist Vinkstraat 2, 3070 Kortenberg, Beļģija**, pilnvaro savu pārstāvi **Kazuhisa Makino** sagatavot tehnisko dokumentāciju un ar mūsu vienpersonisko atbildību paziņot, ka izstrādājums(-), nosaukums: **Bezvada zāles apgriezējmašīna**, veids(-): **DUR193**, atbilst visiem attiecīgajiem direktīvas **2006/42/EC** noteikumiem, kā arī atbilst visiem attiecīgajiem šādu EK/ES direktīvu noteikumiem: **2014/30/EU, 2011/65/EU, 2000/14/EC**, un ir ražots(-) saskaņā ar šādiem harmonizētajiem standartiem: **EN 60335-1:2012+A11:2014+A13:2017+A1:2019+A14:2019+A2:2019, EN 50636-2-91:2014, EN IEC 55014-1:2021, EN IEC 55014-2:2021, EN IEC 63000:2018**.

Direktīvā **2000/14/EC** noteiktā atbilstības novērtēšanas procedūra tika veikta saskaņā ar VI pielikumu.

- Novērtētais skaņas jaudas līmenis: **83,8 dB(A)**,

- Garantētais skaņas jaudas līmenis: **86 dB(A)**.

Pilnvarotā iestāde: **VDE Prüf- und Zertifizierungsinstitut GmbH, Merianstraße 28, 63069 Offenbach, Vācija**.
Identifikācijas numurs: **0366**

Deklarācijas izdošanas vieta: **Kortenberg, Beļģija**. Atbildīgā persona: **Makita Europe N.V. direktors Kazuhisa Makino** (datumu un parakstu skatiet pēdējā lapā)

LIETUVIŲ KALBA

A priedas: ES atitikties deklaracija

Mes, gamintojai **Makita Europe N.V.**, įmonės adresas: **Jan-Baptist Vinkstraat 2, 3070 Kortenberg, Belgija**, įgaliojame **Kazuhisa Makino** parengti techninę bylą ir savo išskirtine atsakomybe deklaruojame, kad gaminys (-iai); žymuo: **Belaidė žoliapjovė**; Tip (-ų) žymuo: **DUR193**. Atitinka visus aktualius **2006/42/EC** nuostatus ir taip pat toliau nurodytų EB/ES direktyvų nuostatus: **2014/30/EU, 2011/65/EU, 2000/14/EC**; be to, pagaminta laikantis šių darnųjų standartų: **EN 60335-1:2012+A11:2014+A13:2017+A1:2019+A14:2019+A2:2019, EN 50636-2-91:2014, EN IEC 55014-1:2021, EN IEC 55014-2:2021, EN IEC 63000:2018**.

Atitikties įvertinimo procedūra pagal direktyvą **2000/14/EC** atitinka VI priedą.

- Išmatuotasis garso galios lygis: **83,8 dB(A)**,

- Garantuotasis garso galios lygis: **86 dB(A)**.

Paskelbtoji įstaiga: **VDE Prüf- und Zertifizierungsinstitut GmbH, Merianstraße 28, 63069 Offenbach, Vokietija**.
Identifikacinis numeris: **0366**

Deklaravimo vieta: **Kortenberg, Belgija**. Atsakingasis asmuo: **Makita Europe N.V. direktorius Kazuhisa Makino** (data ir parašas pateikti paskutiniame puslapyje)

EESTI

Lisa A: EL-i vastavusdeklaratsioon

Meie kui tootjad: **Makita Europe N.V.**, juriidiline aadress: **Jan-Baptist Vinkstraat 2, 3070 Kortenberg, Belgia**, volitame **Kazuhisa Makino** koostama tehnilist toimetik ja kinnitame oma ainuvastutusel, et toode/tooted; nimetus: **Akuga murutrimmer**; Tüübinimetus(ed): **DUR193**; vastab direktiivi **2006/42/EC** kõigile asjaomastele sätetele ning EÜ/EL direktiivide **2014/30/EU, 2011/65/EU, 2000/14/EC** kõigile asjaomastele sätetele ning on toodetud kooskõlas järgmiste ühtlustatud standardite: **EN 60335-1:2012+A11:2014+A13:2017+A1:2019+A14:2019+A2:2019, EN 50636-2-91:2014, EN IEC 55014-1:2021, EN IEC 55014-2:2021, EN IEC 63000:2018**.

Vastavusele hindamise protseduur, mida nõuab direktiiv **2000/14/EC**, teostati vastavalt lisa VI nõuetele.

- Mõõdetud helivõimsuse tase: **83,8 dB(A)**,

- Garanteeritud helivõimsuse tase: **86 dB(A)**.

Teavitatud asutus: **VDE Prüf- und Zertifizierungsinstitut GmbH, Merianstraße 28, 63069 Offenbach, Saksamaa**.
Identifitseerimisnumber: **0366**

Deklareerimiskoht: **Kortenberg, Belgia**. Vastutav isik: **Kazuhisa Makino, direktor – Makita Europe N.V.** (kuupäev ja allkiri viimasel leheküljel)

POLSKI

Aneks A: Deklaracja zgodności UE

My jako producent: **Makita Europe N.V.**, adres firmy: **Jan-Baptist Vinkstraat 2, 3070 Kortenberg, Belgia**. Upoważniamy pana **Kazuhisu Makino** do opracowania dokumentacji technicznej i wydania oświadczenia na naszą wyłączną odpowiedzialność, że produkt(y); Opis: **Akumulatorowa wykaszarka do trawy**. Oznaczenie typu (typów): **DUR193**. Spełniają wszelkie stosowne postanowienia dyrektywy **2006/42/EC** i dodatkowo spełniają wszelkie stosowne postanowienia poniższych dyrektyw WE/UE: **2014/30/EU, 2011/65/EU, 2000/14/EC** i są produkowane zgodnie z następującymi normami zharmonizowanymi: **EN 60335-1:2012+A11:2014+A13:2017+A1:2019+A14:2019+A2:2019, EN 50636-2-91:2014, EN IEC 55014-1:2021, EN IEC 55014-2:2021, EN IEC 63000:2018**.

Procedura oceny zgodności wymagana przez Dyrektywę **2000/14/EC** została przeprowadzona zgodnie z aneksem VI.

- Mierzony poziom mocy akustycznej: **83,8 dB(A)**.

- Gwarantowany poziom mocy akustycznej: **86 dB(A)**.

Organ notyfikowany **VDE Prüf- und Zertifizierungsinstitut GmbH, Merianstraße 28, 63069 Offenbach, Niemcy**. Numer identyfikacyjny: **0366**

Miejsce złożenia deklaracji: **Kortenberg, Belgia**. Osoba odpowiedzialna: **Kazuhisu Makino, Dyrektor Makita Europe N.V.** (data i podpis na ostatniej stronie)

MAGYAR

A. függelék: EU-megfelelőségi nyilatkozat

Felelős gyártóként, a **Makita Europe N.V.**, székhely címe: **Jan-Baptist Vinkstraat 2, 3070 Kortenberg, Belgium**, feljogosítjuk **Kazuhisu Makinót** a műszaki dokumentáció összeállítására, és saját kizárólagos felelősségünkre kijelentjük, hogy a termék(ek); rendeltetése: **Vezeték nélküli fűkasza**; típusmegnevezése: **DUR193**; megfelel a **2006/42/EC** irányelv minden vonatkozó rendelkezésének, továbbá megfelel az alábbi EK/EU irányelvek minden vonatkozó rendelkezésének: **2014/30/EU, 2011/65/EU, 2000/14/EC**, és gyártása az alábbi harmonizált szabványoknak: **EN 60335-1:2012+A11:2014+A13:2017+A1:2019+A14:2019+A2:2019, EN 50636-2-91:2014, EN IEC 55014-1:2021, EN IEC 55014-2:2021, EN IEC 63000:2018**.

A megfelelőségnek a **2000/14/EC** jelű irányelv szerinti megállapítását az **VI. függelék** szerint végeztük.

- Mért zajszint: **83,8 dB(A)**.

- Garantált zajszint: **86 dB(A)**.

Illetékes szervezet: **VDE Prüf- und Zertifizierungsinstitut GmbH, Merianstraße 28, 63069 Offenbach, Németország**. Azonosítási szám: **0366**

A nyilatkozattétel helye: **Kortenberg, Belgium**. Felelős személy: **Kazuhisu Makino, igazgató – Makita Europe N.V.** (datum és aláírás az utolsó lapon)

SLOVENSKY

Príloha A: Vyhlasenie o zhode v rámci EÚ

Naša spoločnosť, ako výrobca: **Makita Europe N.V.**, firemná adresa: **Jan-Baptist Vinkstraat 2, 3070 Kortenberg, Belgicko**. Týmto oprávňujeme **Kazuhisu Makino** na zostavenie technického súboru a vyhlasujeme na našu výhradnú zodpovednosť, že výrobok(ky); Označenie: **Akumulátorová kosačka**. Označenie typu(ov): **DUR193**. Splňa všetky príslušné ustanovenia **2006/42/EC** a taktiež splňa všetky príslušné ustanovenia nasledujúcich smerníc ES/EÚ: **2014/30/EU, 2011/65/EU, 2000/14/EC**, pričom je vyrobená v súlade s nasledujúcimi harmonizovanými normami: **EN 60335-1:2012+A11:2014+A13:2017+A1:2019+A14:2019+A2:2019, EN 50636-2-91:2014, EN IEC 55014-1:2021, EN IEC 55014-2:2021, EN IEC 63000:2018**.

Proces stanovenia zhody vyžadovaný Smernicou **2000/14/EC** sa uskutočnil v súlade s **Prílohou VI**.

- Nameraná hladina akustického výkonu: **83,8 dB(A)**.

- Zaručená hladina akustického výkonu: **86 dB(A)**.

Oboznamený orgán: **VDE Prüf- und Zertifizierungsinstitut GmbH, Merianstraße 28, 63069 Offenbach, Nemecko**. Identifikačné číslo: **0366**

Miesto vyhlásenia: **Kortenberg, Belgicko**. Zodpovedná osoba: **Kazuhisu Makino, riaditeľ – Makita Europe N.V.** (datum a podpis sú uvedené na poslednej strane)

ČESKY

Príloha A: Prohlášení o shodě pro EU

My, jako výrobci: **Makita Europe N.V.**, Adresa firmy: **Jan-Baptist Vinkstraat 2, 3070 Kortenberg, Belgie**. Pověřujeme **Kazuhisu Makino** sestavením technické dokumentace a prohlašujeme na naši vlastní odpovědnost, že produkt(y); Označení: **Akumulátorový vyžinač**. Typové označení: **DUR193**. Splňuje veškerá příslušná ustanovení směrnice **2006/42/EC** a také splňuje všechna související ustanovení následujících směrnic ES/EU: **2014/30/EU, 2011/65/EU, 2000/14/EC** a je vyroben v souladu s následujícími harmonizovanými normami: **EN 60335-1:2012+A11:2014+A13:2017+A1:2019+A14:2019+A2:2019, EN 50636-2-91:2014, EN IEC 55014-1:2021, EN IEC 55014-2:2021, EN IEC 63000:2018**.

Postup posuzování shody vyžadovaný směrnici **2000/14/EC** byl v souladu s **přílohou VI**.

- Naměřená hladina akustického výkonu: **83,8 dB(A)**.

- Zaručená hladina akustického výkonu: **86 dB(A)**.

Notifikovaný orgán: **VDE Prüf- und Zertifizierungsinstitut GmbH, Merianstraße 28, 63069 Offenbach, Německo**. Identifikační číslo: **0366**

Místo prohlášení: **Kortenberg, Belgie**. Odpovědná osoba: **Kazuhisu Makino, ředitel – Makita Europe N.V.** (datum a podpis na poslední straně)

SLOVENSKO

Priloga A: EU-izjava o skladnosti

Mi, podjetje: **Makita Europe N.V.**, poslovni naslov: **Jan-Baptist Vinkstraat 2, 3070 Kortenberg, Belgija**, ko proizvajalec pooblašamo g. **Kazuhisa Makino** za sestavo tehnične datoteke in na lastno odgovornost izjavljamo, da je izdelek; oznaka: **Brezžična kosilnica z nitjo** Oznaka vrst(e): **DUR193**. V skladu z vsemi zadevnimi določili **2006/42/EC** in ustreza zahtevam vseh bistvenih določil naslednjih Direktiv **ES/EU: 2014/30/EU, 2011/65/EU, 2000/14/EC** ter je izdelan v skladu z naslednjimi harmoniziranimi standardi: **EN 60335-1:2012+A11:2014+A13:2017+A1:2019+A14:2019+A2:2019, EN 50636-2-91:2014, EN IEC 55014-1:2021, EN IEC 55014-2:2021, EN IEC 63000:2018**.

Postopek ocene skladnosti, ki ga zahteva Direktiva **2000/14/EC**, je bil izveden v skladu s **Prilogo VI**.

- Izmerjena raven zvočnega hrupa: **83,8 dB(A)**,

- Zagotovljena raven zvočnega hrupa: **86 dB(A)**.

Priglašeni organ: **VDE Prüf- und Zertifizierungsinstitut GmbH, Merianstraße 28, 63069 Offenbach, Nemčija**. Identifikacijska številka: **0366**

Kraj izjave: **Kortenberg, Belgija**. Odgovorna oseba: **Kazuhisa Makino, direktor – Makita Europe N.V.** (datum in podpis na zadnji strani)

SHQP

Shtojca A: Deklarata e konformitetit e BE-së

Ne, si kompania prodhuese: **Makita Europe N.V.**, me adresë biznesi: **Jan-Baptist Vinkstraat 2, 3070 Kortenberg, Belgjikë**, autorizojmë **Kazuhisa Makino** për përpilimin e skedarit teknik dhe deklarojmë se është përgjegjësia jonë e vetme se produkti(et); Përkufizimi: **Kositëse bari me bateri**. Përcaktimi i llojit(eve): **DUR193**, përbush të gjitha dispozitat përkatëse të **2006/42/EC**, gjithashtu përbush edhe të gjitha dispozitat përkatëse të direktivave të mëposhtme të KE-së/BE-së: **2014/30/EU, 2011/65/AU, 2000/14/EC** dhe prodhohen në përputhje me standardet e harmonizuara në vijim: **EN 60335-1:2012+A11:2014+A13:2017+A1:2019+A14:2019+A2:2019, EN 50636-2-91:2014, EN IEC 55014-1:2021, EN IEC 55014-2:2021, EN IEC 63000:2018**.

Procedura e vlerësimit të pajtueshmërisë që kërkohet nga Udhëzimi **2000/14/EC** që në pajtim me **Shtojcën VI**.

- Niveli i matur i fuqisë së zhuurmës: **83,8 dB(A)**,

- Niveli i garantuar i fuqisë së zhuurmës: **86 dB(A)**.

Organi i njoftuar: **VDE Prüf- und Zertifizierungsinstitut GmbH, Merianstraße 28, 63069 Offenbach, Gjermani**. Numri i Identifikimit: **0366**

Vendi i deklaratës: **Kortenberg, Belgjikë**. Personi përgjegjës: **Kazuhisa Makino, drejtor – Makita Europe N.V.** (data dhe firma në faqen e fundit)

БЪЛГАРСКИ

Анекс А: ЕС декларация за съответствие

В качеството си на производител ние: **Makita Europe N.V.**, с адрес на управление: **Jan-Baptist Vinkstraat 2, 3070 Kortenberg, Белгия**, упълномощаваме **Kazuhisa Makino** да състави техническото досие и да декларира от наше име, че продукта(ите): Наименование: **Акумулаторна косачка за трева**. Модел: **DUR193**. Отговаря(т) на съответните разпоредби на **2006/42/EC** и освен това отговаря(т) на съответните разпоредби на следните ЕО/ЕС директиви: **2014/30/EU, 2011/65/EU, 2000/14/EC** и се произвежда(т) в съответствие със следните хармонизирани стандарти: **EN 60335-1:2012+A11:2014+A13:2017+A1:2019+A14:2019+A2:2019, EN 50636-2-91:2014, EN IEC 55014-1:2021, EN IEC 55014-2:2021, EN IEC 63000:2018**.

Процедурата за оценка на съответствието, необходима по силата на **Директива 2000/14/EC**, е в съответствие с **Анекс VI**.

- Измерено ниво на акустична мощност: **83,8 dB(A)**,

- Гарантирано ниво на акустична мощност: **86 dB(A)**.

Нотифициран орган: **VDE Prüf- und Zertifizierungsinstitut GmbH, Merianstraße 28, 63069 Offenbach, Германия**. Идентификационен номер: **0366**

Място на издаване на декларацията: **Kortenberg, Белгия**. Оторизирано лице: **Kazuhisa Makino, Директор – Makita Europe N.V.** (дата и подпис на последната страница)

HRVATSKI

Prilog A: EU Izjava o sukladnosti

Mi kao proizvođači: **Makita Europe N.V.**, sa sjedištem u **Jan-Baptist Vinkstraat 2, 3070 Kortenberg, Belgija** ovlaštujemo **Kazuhisa Makina** za sastavljanje tehničke datoteke i izjavljujemo pod vlastitom isključivom odgovornošću da je proizvod(i); Oznaka: **Bežični trimmer za travu**. Oznaka vrste(a): **DUR193**. Zadovoljava sve relevantne odredbe Direktive **2006/42/EC** i također zadovoljava sve relevantne odredbe sljedećih direktiva **EZ-a/EU-a: 2014/30/EU, 2011/65/EU, 2000/14/EC** i proizvodi se u skladu sa sljedećim usklađenim normama: **EN 60335-1:2012+A11:2014+A13:2017+A1:2019+A14:2019+A2:2019, EN 50636-2-91:2014, EN IEC 55014-1:2021, EN IEC 55014-2:2021, EN IEC 63000:2018**.

Postupak ocjene sukladnosti koji zahtijeva **Direktiva 2000/14/EC** bio je u skladu s **Prilogom VI**.

- Izmjerena razina jačine zvuka: **83,8 dB(A)**,

- Zajamčena razina jačine zvuka: **86 dB(A)**.

Nadležno tijelo: **VDE Prüf- und Zertifizierungsinstitut GmbH, Merianstraße 28, 63069 Offenbach, Njemačka**. Identifikacijski broj: **0366**

Mjesto davanja izjave: **Kortenberg, Belgija**. Odgovorna osoba: **Kazuhisa Makino, direktor – Makita Europe N.V.** (datum i potpis na zadnjoj stranici)

МАКЕДОНСКИ

Анекс А: Изјава за сообразност на ЕУ

Ние, производителите: **Makita Europe N.V.**, со деловна адреса: **Jan-Baptist Vinkstraat 2, 3070 Kortenberg, Белгија**. Го овластуваме **Kazuhsa Makino** за составување на техничката датотека и изјавување под наша лична одговорност дека производител(-ите); Ознака: **Безжичен тример за трева**. Ознака на тип(-ови): **DUR193**. Ги исполнува сите релевантни одредби на **2006/42/ЕС** и исто така ги исполнува сите релевантни одредби на следните директиви на ЕЗ/ЕУ: **2014/30/EU, 2011/65/EU, 2000/14/ЕС** и се произведени во согласност со следниве усогласени стандарди: **EN 60335-1:2012+A11:2014+A13:2017+A11:2019+A14:2019+A2:2019, EN 50636-2-91:2014, EN IEC 55014-1:2021, EN IEC 55014-2:2021, EN IEC 63000:2018**.

Постапката за оценување на сообразноста што се бара согласно Директивата **2000/14/ЕС** е во согласност со **Анекс VI**.

- Измерено ниво на звучна моќност: **83,8 dB(A)**,

- Гарантирано ниво на звучна моќност: **86 dB(A)**.

Известен орган: **VDE Prüf- und Zertifizierungsinstitut GmbH, Merianstraße 28, 63069 Offenbach, Германија**. Идентификациски број: **0366**

Место на давање на изјавата: **Kortenberg, Белгија**. Одговорно лице: **Kazuhsa Makino, Директор – Makita Europe N.V.** (датум и потпис на последната страница)

ROMÂNĂ

Anexa A: Declarație de conformitate UE

Noi, **Makita Europe N.V.**, cu sediul social în: **Jan-Baptist Vinkstraat 2, 3070 Kortenberg, Belgia**, în calitate de producători, îl împuternicim pe **Kazuhsa Makino** pentru redactarea fișierului tehnic și declarăm pe proprie răspundere că produsul (produsele): Denumire: **Motocoșitoare pentru iarbă fără cablu**. Denumirea modelului (modelelor): **DUR193**. Respectă toate prevederile relevante ale directivei **2006/42/EC**; de asemenea, respectă toate prevederile relevante ale următoarelor directive CE/UE: **2014/30/EU, 2011/65/EU, 2000/14/ЕС** și este fabricat în conformitate cu următoarele standarde armonizate: **EN 60335-1:2012+A11:2014+A13:2017+A11:2019+A14:2019+A2:2019, EN 50636-2-91:2014, EN IEC 55014-1:2021, EN IEC 55014-2:2021, EN IEC 63000:2018**.

Procedura de evaluare a conformității, solicitată de directiva **2000/14/ЕС**, corespunde **anexei VI**.

- Nivel de putere acustică măsurat: **83,8 dB(A)**,

- Nivel de putere acustică garantat: **86 dB(A)**.

Organism notificat: **VDE Prüf- und Zertifizierungsinstitut GmbH, Merianstraße 28, 63069 Offenbach, Germania**. Număr de identificare: **0366**

Locul declarației: **Kortenberg, Belgia**. Persoana responsabilă: **Kazuhsa Makino, Director – Makita Europe N.V.** (data și semnătura pe ultima pagină)

СРПСКИ

Додатак А: ЕУ декларација о усаглашености

Ми као производител: **Makita Europe N.V.**, пословна адреса: **Jan-Baptist Vinkstraat 2, 3070 Kortenberg, Белгија**, овлаштујемо **Kazuhsa Makino** да састави техничку документацију и под нашом искључивом одговорношћу изјави да следећи производ: ознака: **Безжични тример за траву**. Ознака тип(ов): **DUR193**. Испуњава све одговарајуће одредбе директиве **2006/42/ЕС** и све релевантне одредбе следећих директива ЕЗ/ЕУ: **2014/30/EU, 2011/65/EU, 2000/14/ЕС** и произведен је у складу са следећим хармонизованим стандардима: **EN 60335-1:2012+A11:2014+A13:2017+A11:2019+A14:2019+A2:2019, EN 50636-2-91:2014, EN IEC 55014-1:2021, EN IEC 55014-2:2021, EN IEC 63000:2018**.

Процедура процењивања усклађености према директиви **2000/14/ЕС** је била у складу са **додатком VI**.

- Измерени ниво јачине звука: **83,8 dB(A)**,

- Гарантовани ниво јачине звука: **86 dB(A)**.

Обавештена страна: **VDE Prüf- und Zertifizierungsinstitut GmbH, Merianstraße 28, 63069 Offenbach, Немачка**. Идентификациони број: **0366**

Место изјаве: **Kortenberg, Белгија**. Одговорна особа: **Kazuhsa Makino, директор – Makita Europe N.V.** (датум и потпис се налазе на последњој страници)

РУССКИЙ

Приложение А: Сертификат соответствия ЕС

Производители: **Makita Europe N.V.**, Рабочий адрес: **Jan-Baptist Vinkstraat 2, 3070 Kortenberg, Бельгия**. Уполномочиваем **Kazuhsa Makino** для составления файла технических данных и заявляем со всей нашей ответственностью, что изделие(я); Наименование: **Аккумуляторная Коса**. Обозначение типа(ов): **DUR193**. Удовлетворяет всем соответствующим положениям **2006/42/ЕС**, а также удовлетворяет всем соответствующим положениям следующих Директив ЕС/ЕС: **2014/30/EU, 2011/65/EU, 2000/14/ЕС** и производится согласно следующим гармонизованным стандартам: **EN 60335-1:2012+A11:2014+A13:2017+A11:2019+A14:2019+A2:2019, EN 50636-2-91:2014, EN IEC 55014-1:2021, EN IEC 55014-2:2021, EN IEC 63000:2018**.

Процедура определения соответствия, необходимая по Директиве **2000/14/ЕС**, была проведена согласно **Приложению VI**.

- Измеренный уровень мощности звука: **83,8 дБ(Ср.)**,

- Гарантированный уровень мощности звука: **86 дБ(Ср.)**.

Уполномоченный орган: **VDE Prüf- und Zertifizierungsinstitut GmbH, Merianstraße 28, 63069 Offenbach, Германия**. Идентификационный номер: **0366**

Место декларирования: **Kortenberg, Бельгия**. Ответственное лицо: **Kazuhsa Makino, Директор – Makita Europe N.V.** (дата и подпись на последней странице)

ҚАЗАҚША

А қосымшасы: ЕО-ның сәйкестік жөніндегі мәлімдемесі

Өндіруші ретінде әрекет ететін:

Makita Europe N.V., Жұмыс мекенжайы: **Jan-Baptist Vinkstraat 2, 3070 Kortenberg, Бельгия**

Kazuhsa Makino мырзаға техникалық файлды құрастыру өкілдігін беріп, айрықша жауапкершілікпен келесі өнім(-дер):

Атауы: **Акумуляторлы шалғы**

Түрінің(түрлерінің) коды: **DUR193.**

2006/42/ЕС стандартының барлық тиісті талаптарына, **2014/30/EU**, **2011/65/EU**, **2000/14/EC** ЕҚ/ЕО

директиваларының барлық тиісті талаптарына сәйкес келеді, сондай-ақ **EN 60335-1:2012+A11:2014+A13:2017+A1:2019+A14:2019+A2:2019**, **EN 50636-2-91:2014**, **EN IEC 55014-1:2021**, **EN IEC 55014-2:2021**, **EN IEC 63000:2018** келісілген стандарттарына сәйкес жасап шығарылды деп мәлімдейді.

2000/14/EC директивасына сәйкес талап етілетін сәйкестікті бағалау процедурасы **VI қосымшасына** сәйкес болған.

- Өлшенген акустикалық қуат деңгейі: **83,8 дБ(А)**.

- Келіпдікті акустикалық қуат деңгейі: **86 дБ(А)**.

Нотификация органы: **VDE Prüf- und Zertifizierungsinstitut GmbH, Merianstraße 28, 63069 Offenbach, Германия.**

Идентификатор: **0366**

Мәлімдеме жасалған жер: **Kortenberg, Бельгия.**

Жауапты тұлға: **Kazuhsa Makino, Директор – Makita Europe N.V.** (күні мен қол соңғы бетке қойылған)

УКРАЇНСЬКА

Додаток А: Декларация про відповідність стандартам ЄС

Ми, як виробник: **Makita Europe N.V.**, адреса компанії: **Jan-Baptist Vinkstraat 2, 3070 Kortenberg, Бельгія.**

Надаємо **Kazuhsa Makino**, уповноваження складати технічну документацію і з повною відповідальністю заявляємо щодо виробу(ів) таке; Найменування:

Акумуляторна газонокосарка. Визначення типу(ів): DUR193. Відповідають усім відповідним положенням **2006/42/ЕС**, а також відповідають усім відповідним положенням таких директив **ЄС/ЄС: 2014/30/EU, 2011/65/EU, 2000/14/ЕС** та виготовлені згідно таких єдиних стандартів: **EN 60335-1:2012+A11:2014+A13:2017+A1:2019+A14:2019+A2:2019, EN 50636-2-91:2014, EN IEC 55014-1:2021, EN IEC 55014-2:2021, EN IEC 63000:2018.**

Процедуру оцінки сумісності, що вимагається Директивою **2000/14/ЕС**, проведено відповідно до **Додатка VI.**

- Вимірний рівень потужності звуку: **83,8 дБ(А)**,

- Гарантований рівень потужності звуку: **86 дБ(А).**

Нотифікований орган: **VDE Prüf- und Zertifizierungsinstitut GmbH, Merianstraße 28, 63069 Offenbach, Німеччина.** Ідентифікаційний номер: **0366**

Місце декларування: **Kortenberg, Бельгія.** Відповідальна особа: **Kazuhsa Makino, директор – Makita Europe N.V.** (дата і підпис на останній сторінці)

繁體中文

附錄A: EU符合性聲明

我們以製造商身份:

Makita Europe N.V., 營業地址: **Jan-Baptist Vinkstraat 2, 3070 Kortenberg, 比利時。**

授權 **Kazuhsa Makino** 編寫技術檔案, 並負全責聲明, 下列產品:

產品名稱: **充電式割草機**

產品類型: **DUR193。**

符合 **2006/42/EC** 的所有相關條款, 並且符合下列 **EC/EU** 法規的所有相關條款: **2014/30/EU**、**2011/65/EU**、**2000/14/EC** 並且根據下列經過協調的標準製造: **EN 60335-1:2012+A11:2014+A13:2017+A1:2019+A14:2019+A2:2019**、**EN 50636-2-91:2014**、**EN IEC 55014-1:2021**、**EN IEC 55014-2:2021**、**EN IEC 63000:2018。**

2000/14/EC 法規要求的符合性評估程序以附錄 VI 為依據。

- 測得的聲音功率電平: **83.8 dB(A)**,

- 保證的聲音功率電平: **86 dB(A)**。

通知團體: **VDE Prüf- und Zertifizierungsinstitut GmbH, Merianstraße 28, 63069 Offenbach, 德國。**

識別號碼: **0366。**

聲明地點: **Kortenberg, 比利時。**

負責人: **Kazuhsa Makino, 指導者 – Makita Europe N.V.** (日期與簽名在最後一頁)

ENGLISH (UK)

Annex A: Declaration of Conformity

We as the manufacturers: **Makita Europe N.V.**, Business address: **Jan-Baptist Vinkstraat 2, 3070 Kortenberg, BELGIUM.** Authorize **Kazuhsa Makino** for the compilation of the technical file and declare under our sole responsibility that the product(s); Designation: **Cordless Grass Trimmer.** Designation of Type(s): **DUR193.** Fulfills all the relevant provisions of **S.I. 2008/1597 (as amended)** and also fulfills all the relevant provisions of the following UK Regulations: **S.I. 2016/1091 (as amended)**, **S.I. 2012/3032 (as amended)**, **S.I. 2001/1701 (as amended)**. and are manufactured in accordance with the following Designated Standards: **EN 60335-1:2012+A11:2014+A13:2017+A1:2019+A14:2019+A2:2019, EN 50636-2-91:2014, EN IEC 55014-1:2021, EN IEC 55014-2:2021, EN IEC 63000:2018.**

The conformity assessment procedure required by **S.I. 2001/1701** was in accordance with **Schedule 9.**

- Measured Sound Power Level: **83.8 dB(A)**,

- Guaranteed Sound Power Level: **86 dB(A)**.

Notified Body: **VDE Prüf- und Zertifizierungsinstitut GmbH, Merianstraße 28, 63069 Offenbach, Germany.** Identification number: **0366.**

Place of declaration: **Kortenberg, Belgium.** Responsible person: **Kazuhsa Makino, Director - Makita Europe N.V.** (date and signature on the last page)

Importer: **Makita (UK) Limited, Michigan Drive, Tongwell, Milton Keynes, Buckinghamshire, MK15 8JD, UK**



28.6.2023

Makita Europe N.V.

Jan-Baptist Vinkstraat 2, 3070 Kortenberg, Belgium



IDE

885961C508



LITHIUM BATTERIES TEST SUMMARY

IN ACCORDANCE WITH SUB-SECTION 38.3 OF UN MANUAL OF TESTS AND CRITERIA

1	Product Manufacturer	Makita Corporation 3-11-8, Sumiyoshi-cho, Anjo, Aichi, 446-8502, Japan Phone : +81 (0)566-98-1711 www.makita.com
2	Model	Detachable Lithium-ion Batteries – Rechargeable Makita Type : BL Separable Lithium-ion Batteries – Rechargeable Makita Type : PDC Integral Lithium-ion Batteries – Rechargeable for Makita Cordless Cleaner Integral Lithium-ion Batteries – Rechargeable for Makita Cordless Screwdriver For detailed list of models see product test information table
3	Voltage rating	3.6V / 7.2V / 10.8V (12Vmax.) / 14.4V / 18V / 36V (40Vmax.) / 57.6V (64Vmax)
4	Ah rating	1.3Ah / 1.5Ah / 2.0Ah / 2.5Ah / 3.0Ah / 4.0Ah / 5.0Ah / 6.0Ah / 33.5Ah
5	Wh rating	5.4Wh / 10.8Wh / 14.0Wh / 16.2Wh / 17.0Wh / 22.0Wh / 27.0Wh / 28.08Wh / 35.1Wh / 36.0Wh / 44.0Wh / 54.0Wh / 58.0Wh / 72.0Wh / 80.0Wh / 87.0Wh / 90.0Wh / 94.0Wh / 108.0Wh / 144.0Wh / 180.0Wh / 230.2Wh / 288.0Wh / 1206Wh

List of Tests Conducted and Results

PERFORMED TESTS		RESULTS
38.3.4.1 T1	Altitude Simulation	Passed
38.3.4.2 T2	Thermal Test	Passed
38.3.4.3 T3	Vibration	Passed
38.3.4.4 T4	Shock	Passed
38.3.4.5 T5	External Short Circuit	Passed
38.3.4.7 T7	Overcharge	Passed

(Note that tests T6 and T8 are not applicable to batteries.)



Revision Date: 2021-11-19	Revision Number: 3.0
RESEARCH & DEVELOPMENT PLANNING DEPARTMENT GENERAL MANAGER Yoshihisa Inuzuka	Signature 

The UN 38.3 tests were performed by one of the following test houses and were tested to UN Manual Test and Criteria Revision 3 Amendment 1 or subsequent revisions or amendments.

<p>Tohoku Murata Manufacturing Co., Ltd. 1-1 Shimosugishita, Takakura, Hiwada-machi, Koriyama-shi, Fukushima, 963-0531 Japan Phone: +81-24-955-7770 e-mail: tmm-qa-compliance@murata.com Website: https://www.murata.com/en-global/group/tohokumurata</p>	<p>Samsung SDI Co., Ltd 467, Beonyeong-ro, Seobuk-gu, Cheonan-si, Chungcheongnam-do, Korea Phone: +82-41-560-3114 e-mail: lian55.kim@samsung.com Website: http://samsungsdi.co.kr</p>
<p>CQC Intime Testing Technology Co.,Ltd. East Taihu Technology and Finance City, No.1368 Wuzhong Dadao Rd., Wuzhong Economic Development Zone, Suzhou, Jiangsu. Phone: 0512-66303623 e-mail: cqc_jszlb@126.com Website: http://www.cqc-it.com</p>	<p>Celxpert(Kunshan) Energy Co.Ltd NO.1111,Hanpu Road,Yushan Town,Kunshan City,Jiangsu Province,P.R.China Phone: +86-0512-57775999-8239 e-mail: Frank_Gao@cn.celxpert.com Website: http://www.celxpert.com.tw</p>
<p>Murata Energy Device Wuxi Co., Ltd. No.27 Changjiang Road, New District,Wuxi,Jiangsu Province, 214028 P.R.C. Phone: +86-510-8523-9120 e-mail: mdw-qa-comp@murata.com Website: https://www.murata.com/en-global/group/tohokumurata</p>	<p>Shanghai Research Institute of Chemical Industry Testing Center No.345 East Yunling Road, Putuo, Shanghai,China Phone: +86-21-3176555 e-mail: battery@ghs.cn Website: http://www.ghs.cn</p>
<p>HCT CO.,LTD. 74, Seoicheon-ro 578beon-gil, Majang- myeon, Icheon-si, Gyeonggi-do, 17383 KOREA Phone:031-645-6300 e-mail:E_safety@hct.co.kr Website: http://www.hct.co.kr/</p>	



Description of Battery and Test Information

Model numbers	Physical Description	Battery weight (kg)	Wh rating	Test report number	Test report date	Applicable UN Numbers acc. to UN Model Regulations
BL0715 7.2V 1.5 Ah	Detachable cluster lithium-ion accumulator	0.12	10.8	QA-7349	10-Oct-2017	UN3480/ UN3481
BL1013/BL1014 10.8V/12Vmax. 1.3Ah	Detachable cluster lithium-ion accumulator	0.17	14.0	QA-7332 QA-7357	4-Oct-2017 20-Oct-2017	UN3480/ UN3481
BL1013/BL1014 10.8V/12Vmax. 1.3Ah	Detachable slide in lithium-ion accumulator	0.18	14.0	MT0038801	4-Mar-2011	UN3480/ UN3481
BL1015/BL1016 10.8V/12Vmax. 1.5Ah	Detachable slide in lithium-ion accumulator	0.25	17.0	CPK-QA-Lab- UN383PACK1402 CPK-Lab- UN383PACK15060	16-Aug-2014 16-Aug-2015	UN3480/ UN3481
BL1015/BL1016 10.8V/12Vmax. 1.5Ah	Detachable slide in lithium-ion accumulator	0.21	16.2	CPK-Lab- UN383PACK21053-A CPK-Lab- UN383PACK21054-A	05-Aug-2021 07-Aug-2021	UN3480/ UN3481
BL1021B 12Vmax. 2.0Ah	Detachable slide in lithium-ion accumulator	0.24	22.0	CPK-QA-Lab- UN383PACK15063	20-Aug-2015	UN3480/ UN3481
BL1040B/BL1041B 10.8V/12Vmax. 4.0Ah	Detachable slide in lithium-ion accumulator	0.43	44.0	CPK-Lab- UN383PACK14042 CPK-QA-Lab- UN383PACK15062	23-Dec-2014 23-Aug-2015	UN3480/ UN3481
BL1415N 14.4V 1.5Ah	Detachable slide in lithium-ion accumulator	0.32	22.0	SDI-UN-131101-02	17-Dec-2017	UN3480/ UN3481
BL1415NA 14.4V 1.5Ah	Detachable slide in lithium-ion accumulator	0.40	21.6	MT0045738	15-Jul-2011	UN3480/ UN3481
BL1430B 14.4V 3.0Ah	Detachable slide in lithium-ion accumulator	0.50	44.0	SDI-UN-P160118-01	18-Jan-2016	UN3480/ UN348
BL1440 14.4V 4.0Ah	Detachable slide in lithium-ion accumulator	0.53	58.0	QA-7358	20-Oct-2017	UN3480/ UN3481
BL1450 14.4V 5.0Ah	Detachable slide in lithium-ion accumulator	0.51	72.0	SDI-UN-P140807-01	11-Aug-2014	UN3480/ UN348



BL1460A 14.4V 6.0Ah	Detachable slide in lithium-ion accumulator	0.54	87.0	CPK-QA-Lab- UN383PACK15061	12-June-2015	UN3480/ UN3481
BL1460B 14.4V 6.0Ah	Detachable slide in lithium-ion accumulator	0.54	87.0	CPK-QA-Lab- UN383PACK15027	12-June-2015	UN3480/ UN3481
BL1415G 14.4V 1.5Ah	Detachable slide in lithium-ion accumulator	0.33	22.0	CPK-QA-Lab- UN383PACK16008	01-Mar-2016	UN3480/ UN3481
BL1415G 14.4V 1.5Ah	Detachable slide in lithium-ion accumulator	0.32	22.0	CPK-QA-Lab- UN383PACK21006-A	22-Mar-2021	UN3480/ UN3481
BL1420G 14.4V 2.0Ah	Detachable slide in lithium-ion accumulator	0.33	28.08	CPK-Lab- UN383PACK21007- A-1-1	23-Mar-2021	UN3480/ UN3481
BL1815N 18V 1.5Ah	Detachable slide in lithium-ion accumulator	0.36	27.0	MT0059172	15-Feb-2012	UN3480/ UN3481
BL1815N 18V 1.5Ah	Detachable slide in lithium-ion accumulator	0.36	27.0	CPK-QA-Lab- UN383PACK13025	13-Oct-2013	UN3480/ UN3481
BL1820B 18V 2.0Ah	Detachable slide in lithium-ion accumulator	0.38	36.0	QA-7337	5-Oct-2017	UN3480/ UN3481
BL1830B 18V 3.0Ah	Detachable slide in lithium-ion accumulator	0.64	54.0	QA-7344	5-Oct-2017	UN3480/ UN3481
BL1830B 18V 3.0Ah	Detachable slide in lithium-ion accumulator	0.60	54.0	SDI-UN-P160314-01	14-Mar-2016	UN3480/ UN3481
BL1840B 18V 4.0Ah	Detachable slide in lithium-ion accumulator	0.65	72.0	QA-7285	1-Sep-2017	UN3480/ UN3481
BL1840B 18V 4.0Ah	Detachable slide in lithium-ion accumulator	0.60	72.0	SDI-UN-P150209-01	10-Feb-2015	UN3480/ UN3481
BL1850B 18V 5.0Ah	Detachable slide in lithium-ion accumulator	0.64	90.0	QA-7286	1-Sep-2017	UN3480/ UN3481
BL1850B 18V 5.0Ah	Detachable slide in lithium-ion accumulator	0.62	90.0	SDI-UN-P160104-01	4-Jan-2016	UN3480/ UN3481



BL1860B 18V 6.0Ah	Detachable slide in lithium-ion accumulator	0.67	108.0	2017126J17835	7-Dec-2017	UN3480/ UN3481
BL1815G 18V 1.5Ah	Detachable slide in lithium-ion accumulator	0.39	27.0	CPK-QA-Lab- UN383PACK16012	23-Mar-2016	UN3480/ UN3481
BL1815G 18V 1.5Ah	Detachable slide in lithium-ion accumulator	0.38	27.0	CPK-Lab- UN383PACK21003-A	03-Mar-2021	UN3480/ UN3481
BL1820G 18V 2.0Ah	Detachable slide in lithium-ion accumulator	0.39	35.1	CPK-Lab- UN383PACK21004- A-1-1-1-1-1	09-Mar-2021	UN3480/ UN3481
BL3626 36V 2.6Ah	Detachable slide in lithium-ion accumulator	1.34	94.0	QA-7346	6-Oct-2017	UN3480/ UN3481
BL3622A 36V 2.2Ah	Detachable slide in lithium-ion accumulator	1.33	80.0	QA-7348	6-Oct-2017	UN3480/ UN3481
Integral Batteries for DF001D	Integral lithium- ion accumulator	0.13	5.4	CPK-QA-Lab- UN383PACK16026	26-Dec-2016	UN3480/ UN3481
Integral Batteries for CL105D / CL110D	Integral lithium- ion accumulator	0.18	14.0	CPK-QA-Lab- UN383PACK13028- K092-1-1	18-May-2014	UN3480/ UN3481
Integral Batteries for CL104D / CL111D	Integral lithium- ion accumulator	0.18	17.0	CPK-QA-Lab- UN383PACK16022-1- 1-1-1	27-Feb-2018	UN3480/ UN3481
BL1020V 10.8V/12Vmax. 2.0Ah	Integral lithium- ion accumulator	0.185	22.0	CPK-Lab- UN383PACK20004-A	21-Feb-2020	UN3480/ UN3481
BL4025 40Vmax. 2.5Ah	Detachable slide in lithium-ion accumulator	0.70	90.0	MDW-B19090	12-Sep-2019	UN3480/ UN3481
BL4040 40Vmax. 4.0Ah	Detachable slide in lithium-ion accumulator	1.04	144.0	1119040200	20-May-2019	UN3480/ UN3481
BL4020 40Vmax. 2.0Ah	Detachable slide in lithium-ion accumulator	0.68	72.0	1120010340	27-Feb-2020	UN3480/ UN3481
BL4050F 40Vmax. 5.0Ah	Detachable slide in lithium-ion accumulator	1.31	180.0	1120050246	28-Jun-2020	UN3480/ UN3481



BL4080F 40Vmax. 8.0Ah	Detachable slide in lithium-ion accumulator	1.90	288.0	1121030246	16-Apr-2021	UN3480/ UN3481
PDC1200 36V 33.5Ah	Separable lithium-ion accumulator	8.80	1206	HCT-BA-2002-RE016	13-Feb-2020	UN3480/ UN3481
BL6440 57.6V 4.0Ah	Separable lithium-ion accumulator	2.20	230.2	1120090534	28-Sep-2020	UN3480/ UN3481

<optional company logo>



**Safety Information for
Lithium Ion Batteries for
Cordless Power Tools and
Electric Garden Equipment**



August 2021

PRELIMINARY REMARKS

EC

These batteries are neither "substances" nor "preparations" according to the REACH Regulation 1907/2006 EC. They have, however, to be regarded as "articles" which are not intended to release substances under normal or reasonably foreseeable conditions of use. Therefore it is not required to provide a Safety Data Sheet according to article 31 of the REACH Regulation (EC) 1907/2006.

US

Material Safety Data Sheets (MSDS) are a sub-requirement of the Occupational Safety and Health Administration (OSHA) Hazard Communication Standard, 29 CFR Subpart 1910.1200. This Hazard Communication Standard does not apply to various subcategories including anything defined by OSHA as an "article". OSHA has defined "article" as a manufactured item other than a fluid or particle;

- (i) which is formed to a specific shape or design during manufacture;
- (ii) which has end use function(s) dependent in whole or in part upon its shape or design during end use; and
- (iii) which under normal conditions of use does not release more than very small quantities, e.g. minute or trace amounts of a hazardous chemical, and does not pose a physical hazard or health risk to employees.

Because all of our batteries are defined as "articles", they are exempted from the requirements of the Hazard Communication Standard.

1. IDENTIFICATION OF THE PRODUCT AND OF THE COMPANY

Product Name:

Lithium-ion Batteries - Rechargeable
Makita Type : BLXXXX(Y) BLXXXXX(Y) BLXXXX(YY) LXXXX PDCXXXX
DOLMAR Type : AP-XXX AP-XXXX

Note:

XXX : "XXX" represents 3 digit numbers
XXXX : "XXXX" represents 4 digit numbers
XXXXX : "XXXXX" represents 5 digit numbers
(Y) or (YY) : A letter or two letters may be followed after the 4 or 5 digit numbers
(ex. BL7010, BL1850B, BL1415NA, BL36120A etc.)



Integral Lithium-ion Batteries –Rechargeable
Makita Cordless Cleaner Type :CLXXXD
Makita Cordless Screwdriver Type :DFXXXD

Note:

XXX : "XXX" represents 3 digit numbers
(ex. CL105D, DF001D etc.)

Manufacturer:

Makita Corporation
3-11-8, Sumiyoshi-cho, Anjo, Aichi,
446-8502, Japan
Phone : +81 (0)566-98-1711
www.makita.com

<p><optional company logo></p> 	<p>Safety Information for Lithium Ion Batteries for Cordless Power Tools and Electric Garden Equipment</p>	
--	---	---

August 2021

2. HAZARDS IDENTIFICATION

Lithium ion batteries have a gas-tight seal and not hazardous when used and handled in accordance with the manufacturer's specifications.

3. COMPOSITION / INFORMATION ON INGREDIENTS

Cathode: Li-, Ni-, Co-, Mn-, Al- containing oxides (active material), polyvinylidene fluoride (binder), carbon (conductive material), additives, aluminium foil

Anode: carbon (active material), silicon monoxide (active material), polyvinylidene fluoride(binder), styrene-butadiene rubber(binder), Carboxymethyl cellulose sodium salt(binder), Organic polymer (binder), additives, copper foil

Electrolyte: organic solvents (non aqueous liquids), lithium salt, additives,

The product does not contain metallic lithium or lithium alloys.

4. FIRST AID MEASURES

Skin or eye contact with released substances (electrolyte):

Rinse eyes thoroughly with water for at least 15 minutes. Seek medical attention.

Chemical Burns:

Chemical burns require appropriate treatment. Seek medical attention.

Respiratory tract:

In case of intensive smoke generation or gas release immediately leave the room. In case of large quantities and irritation of the respiratory tract, seek medical attention. Ensure sufficient ventilation.

Swallowing:

Rinse mouth and vicinity with water. Seek immediate medical attention.

5. FIREFIGHTING MEASURES

Fires from lithium batteries can basically be fought with water. There is no need for additional or special extinguishing agents. Surrounding fires can be fought with conventional extinguishing agents. The fire of a battery cannot be considered separately from the surrounding fire.

The cooling effect of water effectively prevents surrounding fire from spreading to batteries which have not yet reached the critical ignition ("thermal runaway") temperature.

Reduce fire load by separating large quantities and moving them away from the area of risk.

During a fire, gases may develop which may cause injuries of the respiratory tract. Take care of sufficient respiratory protection.

6. ACCIDENTAL RELEASE MEASURES

When damaged the battery housing may release electrolyte. Seal batteries in an airtight plastic bag, add dry sand, chalk powder (CaCO₃) or vermiculite. Traces of electrolyte can be absorbed with dry paper towels. Wear protective gloves in order to prevent direct contact with skin. Thoroughly rinse contaminated areas with water.



Use appropriate personal protective equipment (protective gloves, protective clothing, protective mask, respiratory protection).

7. HANDLING AND STORAGE

Handling and Occupational Safety

Handle discharged batteries with care

Even when discharged, batteries represent a risk as they may deliver a very high short-circuit current. Even if they seem to be discharged lithium ion batteries need to be treated as carefully as if they were not discharged.

<p><optional company logo></p> 	<p>Safety Information for Lithium Ion Batteries for Cordless Power Tools and Electric Garden Equipment</p>	
--	---	---

August 2021

Avoid impact and physical damage

Impact and penetration may damage the battery. This may cause leakage, heat generation, smoke, fire, or explosion.

Keep batteries away from other metal objects

Paperclips, coins, keys, nails, screws or other metal objects can short the terminals. This may cause burns or fire.

Under abusive conditions liquid may be released from the battery

Avoid contact with battery liquids. Rinse with water. Upon contact with eyes, seek also medical assistance. Liquid released from the battery may cause irritation or chemical burns.

Do not expose a batteries to fire or excessive temperature

Exposure to fire or temperature above 130 °C may cause fire, explosion and personal injuries. Do not incinerate batteries except for permitted waste incinerators.

Do not disassemble batteries

Disassembly or modification of the battery may damage the protection circuit. This may cause heat generation, smoke, fire, or explosion.

Do not immerse batteries in liquids like water or beverages

Exposure to liquids may damage the battery. This may cause heat generation, smoke, fire, or explosion.

Use only chargers recommended by the manufacturer

Chargers which are not suited for the battery being recharged may be damaged. This may cause fire.

Use cordless power tools and electric garden equipment only with designated batteries

Use of cordless power tools and electric garden equipment with other batteries may lead to battery damage. This may cause fire and personal injury.

Do not use damaged or modified batteries

Damaged or modified batteries may exhibit unpredictable risks. This may cause fire, explosion and personal injury.

Do not use defective batteries

Immediately stop using batteries when abnormalities are noticed, such as smell, heat, discoloration, or deformation. Otherwise the battery may be damaged. This may cause heat generation, smoke, fire, or explosion.

Storage

Always carefully observe warning notices on batteries and in instructions for use. Use only recommended battery types.

Lithium batteries preferably are to be stored at ambient temperature and in dry places (max. 50 °C). Large temperature fluctuations are to be avoided. (For example, do not store near heat radiators, do expose to sunlight for sustained periods).

Consult local authorities and insurers when storing large quantities of lithium batteries.

8. EXPOSURE CONTROLS / PERSONAL PROTECTION

Not applicable. Lithium ion batteries are products, which do not release substances under normal and reasonably foreseeable conditions of use. Therefore there is normally no need for exposure controls and personal protection

9. PHYSICAL AND CHEMICAL PROPERTIES

Compact batteries with (plastic) housing, terminals

10. STABILITY AND REACTIVITY

When an upper temperature limit of (e.g. 130°C) is exceeded, batteries may rupture or the pressure relief mechanism may be activated.

<optional company logo>



Safety Information for Lithium Ion Batteries for Cordless Power Tools and Electric Garden Equipment



August 2021

Exceeding a storage temperature of 60 °C may lead to accelerated ageing and premature loss of function.

11. TOXICOLOGICAL INFORMATION

Lithium ion batteries are products, which do not release substances under normal and reasonably foreseeable conditions of use. In case of damaged ingredients may be released.

12. ECOLOGICAL INFORMATION

Lithium ion batteries do not contain heavy metals (such as lead, cadmium or mercury).

13. DISPOSAL CONSIDERATIONS

In the EU, used batteries must not be disposed of with household waste and not be mixed with batteries of other systems in order to prevent risk for man and environment and not to exacerbate recycling.

Used batteries shall be returned (free of charge) to the point of sale or to a collection system (industry, distribution).

According to the EU battery directive, lithium batteries are marked with the symbol indicating 'separate collection' (crossed-out wheeled bin shown below).



To prevent short circuits and associated heating, lithium batteries must not be stored or transported in bulk form and unprotected. Suitable measures against short circuits include:

- Placing the batteries in original packaging or a plastic bag
- Individual protection of battery contacts (e.g. using insulating tape)
- Embedding in dry sand

14. TRANSPORT INFORMATION

Commercial transport of lithium ion batteries is subject to dangerous goods regulations. Transport preparations and transport are exclusively to be carried out by appropriately trained personnel and/or the process has to be accompanied by experts with suitable knowledge or qualified companies.

Transport regulations:

Lithium batteries are subject to the following dangerous goods regulations and exemptions based on the respective valid revision:

Class 9

UN 3480: LITHIUM ION BATTERIES

UN 3481: LITHIUM ION BATTERIES CONTAINED IN EQUIPMENT,
(i.e. inserted in battery operated product) or



LITHIUM ION BATTERIES PACKED WITH EQUIPMENT
(i.e. packed together with battery operated product)

ADR, RID

Special provisions: 188, 230, 310, 376, 377, 636

Packing instructions: P903, P908, P909, LP903, LP904

Tunnel category E

<p><optional company logo></p> 	<p>Safety Information for Lithium Ion Batteries for Cordless Power Tools and Electric Garden Equipment</p>	
--	---	---

August 2021

IMDG Code

Special provisions: 188, 230, 310, 348, 360, 376, 377
Packing instructions: P903, P908, P909, LP903, LP904
EmS: F-A, S-I
Stowage category A

ICAO, IATA-DGR

Special provisions: A88, A99, A154, A164, A181, A182, A183, A185, A201
Packing instructions: 965, 966, 967

All transport modes

[Test methods and requirements

In accordance with the dangerous goods regulations for lithium batteries, each new type of cell or battery must have passed all tests listed in the UN Manual of Tests and Criteria, Part III, Section 38.3. This particularly applies also if multiple cells or batteries have been assembled into new batteries (battery packs or battery assemblies). Therefore it should be confirmed here that batteries as distributed by the manufacturer/supplier have passed the respective tests.

These requirements also apply to used batteries. Used batteries that are intact and undamaged can usually be transported under the regulations for unused batteries]

Defective or damaged batteries are subject to more stringent regulations. These regulations may prohibit the transport completely. A general ban applies to air transport (IATA DGR - special provision A154).

For transport of used - but not damaged - batteries please refer to the respective special provisions.

Waste batteries and batteries which are sent for recycling or disposal are prohibited from air transport (IATA Special provision A 183).

Exemptions need to be approved in advance by the competent authority of the country of origin and the respective country of the airline.

15. REGULATORY INFORMATION

Regardless of shape, volume, weight and application, batteries, in the EU are subject to the respective national implementation of the European Battery Directive (2006/66/EC). It includes but is not limited to regulations regarding placing on the market, collection, treatment and recycling of batteries.

Transport regulations are according to IATA, ADR, IMDG, RID. Refer to section 14.

16. OTHER INFORMATION

This information provides assistance for compliance with legal requirements, but does not replace them. It is based on our present knowledge.

The above information was compiled to the best of our knowledge and belief.

The information does not represent any warranties. Distributors and users of the product have to take their own responsibility to observe applicable laws and regulations.